

SCALE

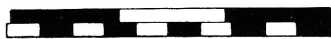

Metres
Feet

VICKERS WELLINGTON Mk.Ic
Front view

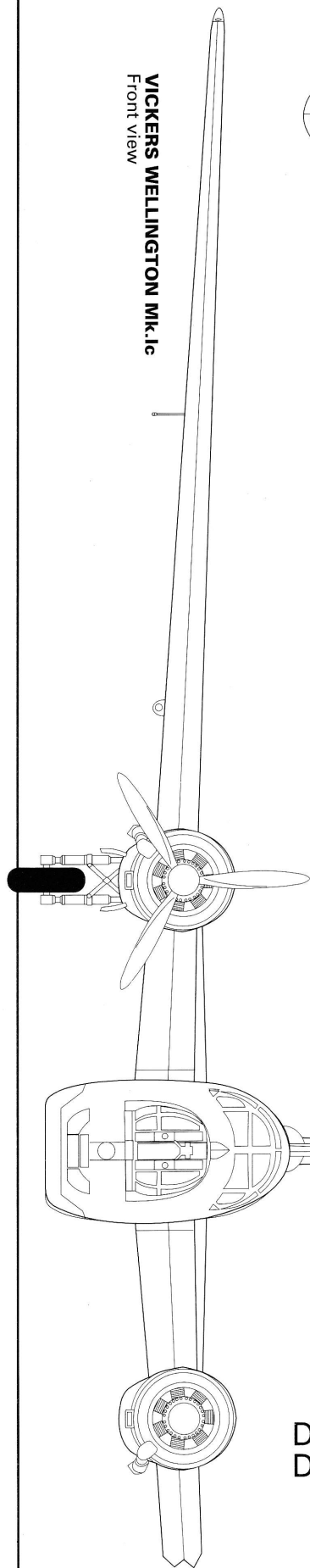

VICKERS WELLINGTON Mk.Ic
Port side view

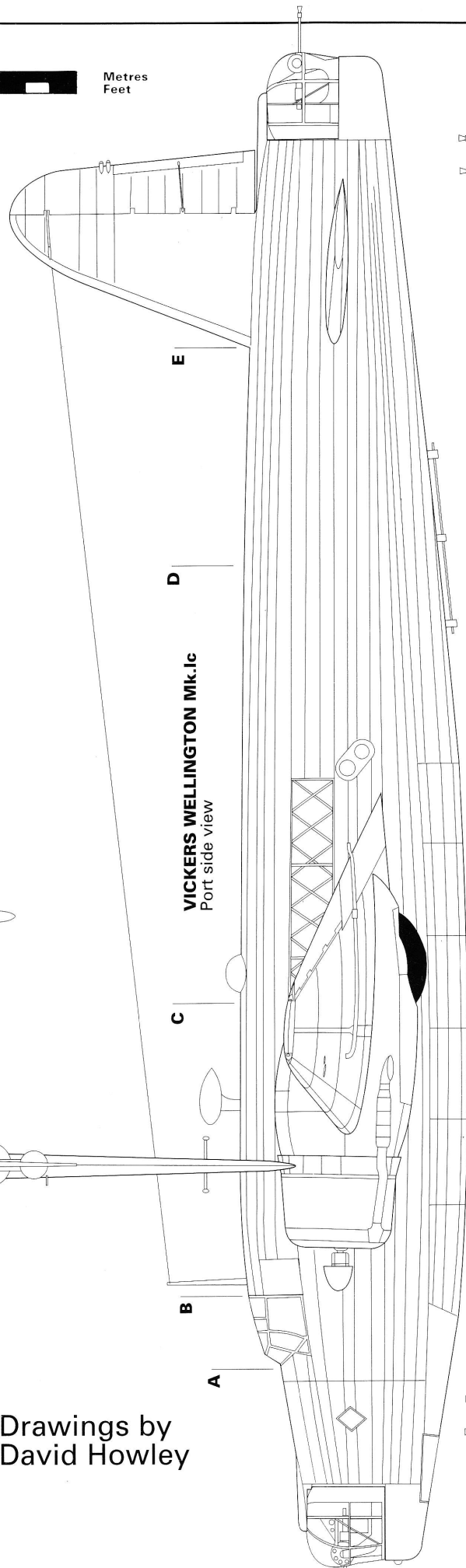

Drawings by
David Howley

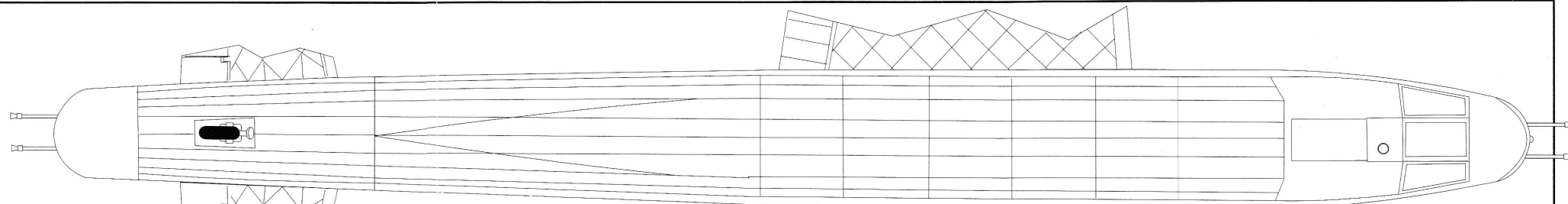

VICKERS WELLINGTON Mk.Ic
Underside plan view

Scrap view of Wellington tailplane
fitted to Mk. II, III and X

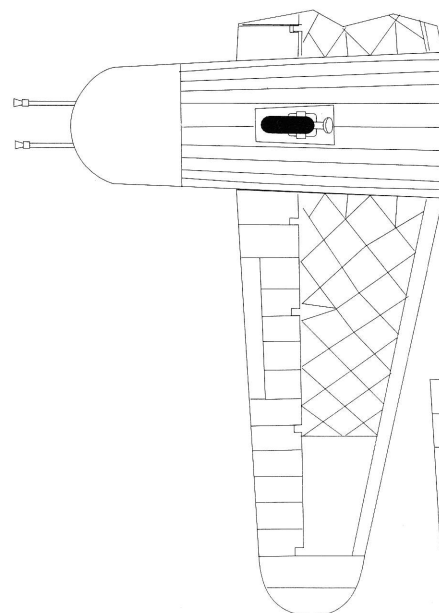

VICKERS WELLINGTON Mk.II
Scrap port side view showing differences
in Merlin engine layout

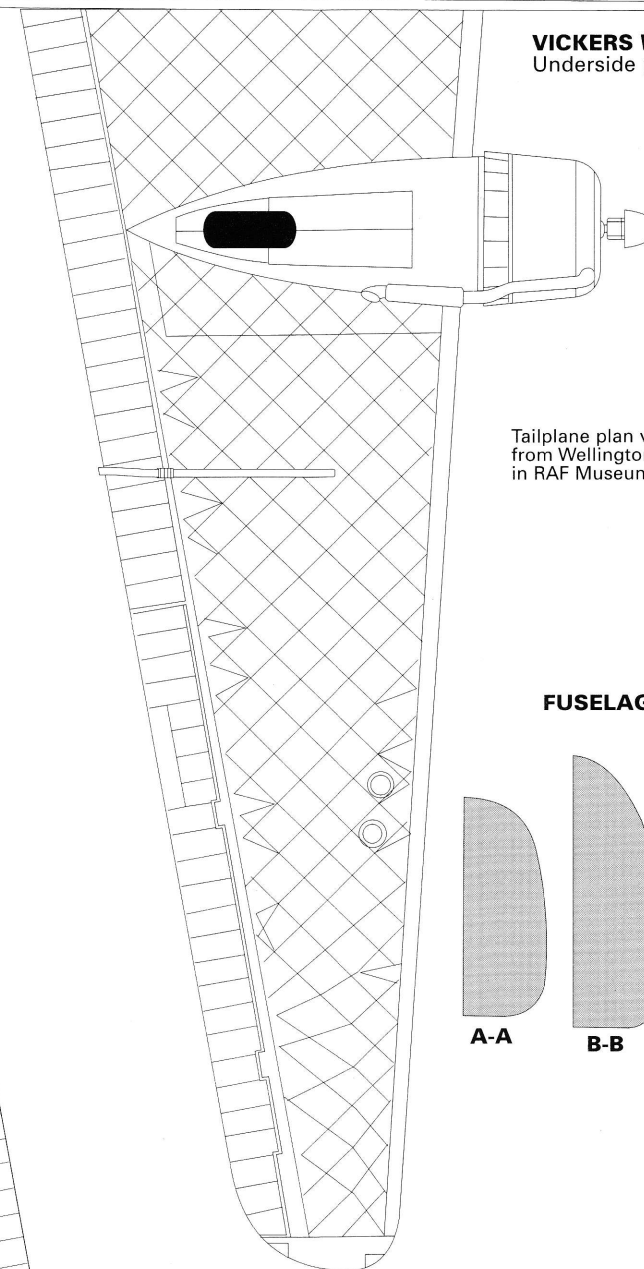
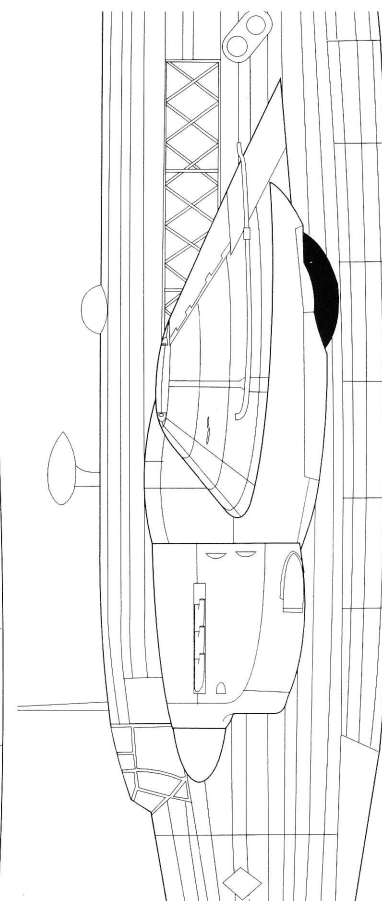

Vickers WELLINGTON

VICKERS WELLINGTON Mk.Ic
Upper surface plan view

Tailplane plan view
from Wellington T.10
in RAF Museum.

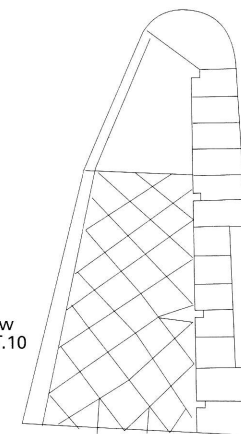

FUSELAGE CROSS SECTIONS

